

## **ARDUINO BASED TEMPERATURE INDICATOR BY USING LM 35 TEMPERATURE SENSOR AND AN RGB LED**

Hla Htay Win<sup>1</sup>, Ar Kar<sup>2</sup>, Htee Mu Wah<sup>3</sup>, Ei Cherry Hlaing<sup>4</sup>

### **Abstract**

The “Temperature Indicator Circuit” is mainly implemented by using Arduino Uno microcontroller board and LM35. The peripheral components are 16 x 2 LCD, HC05 Bluetooth module, android phone, RGB LED (common cathode type), buzzer, fan with motor and relay module. The output data is sent to LCD, an RGB LEDs and android phone from Bluetooth module. An LM35 temperature sensor is used for sensing environment temperature. Different temperature ranges will produce a different color on an RGB LED. The Arduino Uno microcontroller sends the calculated temperature to 16 x 2 LCD and RGB LED and the user by using appropriate commands of LM35 temperature sensor. The sketch for the microcontroller were written in the Arduino programming language, debugged, compiled and burnt into the ATmega328P microcontroller using the Arduino integrated development environment (IDE).

**Keywords :** Arduino Uno,LM35, RGB LED,16 x 2 LCD.

### **Introduction**

The Temperature Indicator circuit can be used as a temperature detector or a more accurate temperature signal indicator. The system is based on the working of temperature controller using LM35 as temperature sensor, RGB LED as signal indicator and LCD as show output signal range. LM35 sensor automatically senses the temperature and works normally within a particular temperature range. -10 to100°C temperature indicator circuit can be controlled with the help of a sensor and reported to the user’ phone every time. The LM35 devices are precision integrated circuit temperature sensors whose output voltage is linearly proportional to the Celsius temperature scale.

An LED and buzzer alarm are used to indicate when the device crosses the set of hot temperature. In this research work, the RGB LED will change colors depending on the temperature of the surrounding environment. Bluetooth module, HC05 is a transceiver that realizes the connection between the smartphone and Arduino board. The block diagram of the system is shown in Figure 1.

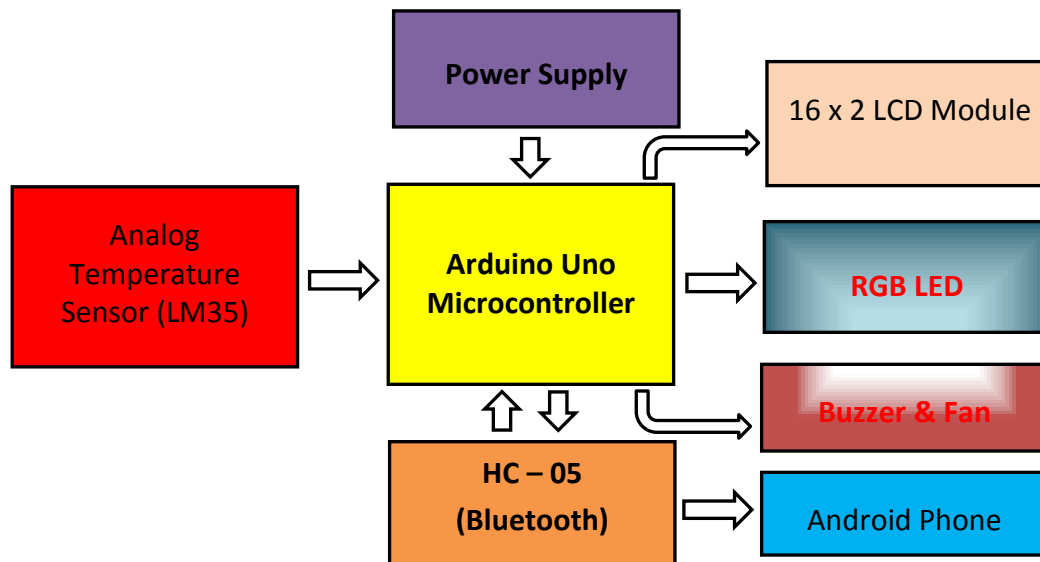
---

<sup>1</sup> Dr, Lecturer, Department of Physics, Bago University

<sup>2</sup> Dr, Assistant Lecturer, Department of Physics, Bago University

<sup>3</sup> PhD Candidate, Assistant Lecturer, Department of Physics, Bago University

<sup>4</sup> Dr, Demonstrator, Department of Physics, Bago University



**Figure 1** The block diagram of the temperature indicator circuit

## Background Theory of the Temperature Indicator Circuit

### Arduino Uno

Arduino Uno board is a microcontroller board based on Atmel Atmega328P 8-bit microprocessor. There are 14 digital input and output pins. 6 - pin of which can be used as pulse width (PWM) output. It has 6 Analog inputs and a 16 MHz quartz crystal or oscillator. Arduino Uno board has USB (universal serial bus) cable to connect to a computer, a power jack, an ICSP (In Circuit Serial Programming) header and a reset button.

Arduino is designed to sense the environment and/or surrounding by receiving input signal through sensors and communicates with its surrounding through actuators. Since the Arduino hardware and software is an open source, it has already many clones of Arduino hardware available with many exciting features, Arduino Uno board is used in this research. [BadamasiY., 2014]

### Temperature Sensor LM35

A temperature sensor, LM35 is designed specifically to measure the hotness or coldness of an object. It is a precision temperature sensor with its output proportional to the temperature in °C. It can be measured more accurately than with a thermistor.

This sensor also possesses low self-heating and does not cause more than 0.1 °C temperature rise in air. The operating temperature range is from -55°C to 150°C. The LM35's low output impedance make interfacing to readout or control circuitry especially easy to use.[Arduino based digital temperature sensor,2016]

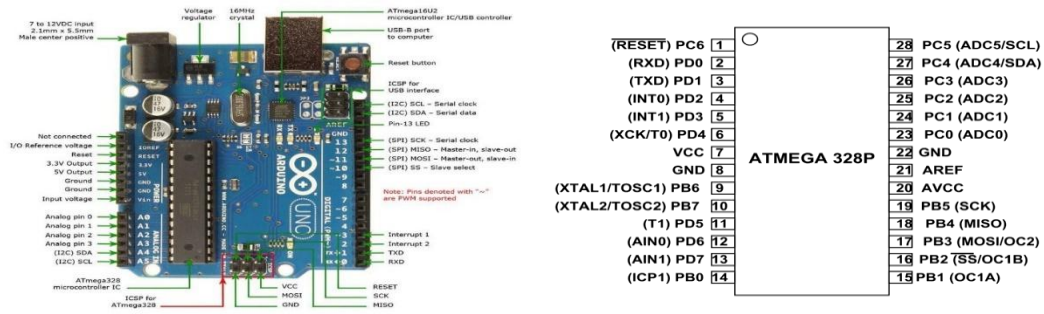


Figure 2 The photograph of Arduino Uno and pin diagram of the ATmega 328P



Figure 3 The photograph of and pin diagram of the LM-35 temperature sensor

**Liquid Crystal Display (LCDs)**

Liquid Crystal Display (LCDs) has 2 lines and can display 16 characters on each line. Nonetheless, when it is interfaced with the microcontroller, the messages can be scrolled with software to display information which is more than 16 characters in length.

The Arduino IDE allows the user to use LCD in 4-bit mode. This type of communication enables the user to decrease the pin usage on Arduino, unlike other the Arduino need not to be programmed separately for using it in 4-bit mode because by default the Arduino is set up to communicate in 4 bit mode. The 4-bit mode of LCD can be used in this circuit.<sup>[ Pimpalgaonkar A.& at el,2013]</sup>

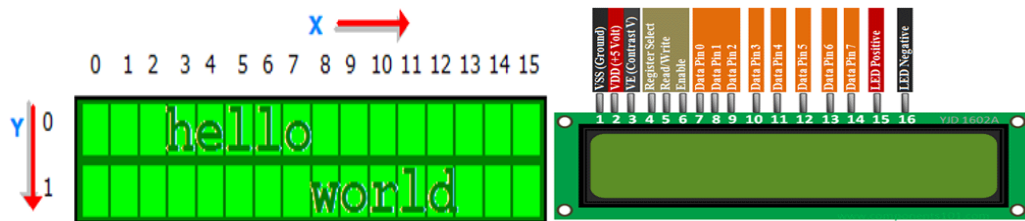
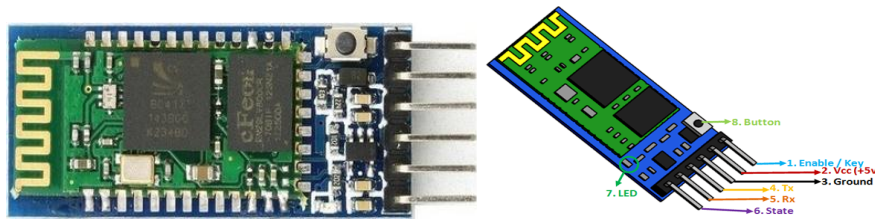


Figure 4 The position photograph and pin diagram of the 16x2 LCD display

**HC05 Bluetooth Module**

Bluetooth is a technology for wireless communication to apply long term. It is designed to replace cable connections. It uses serial communication to communicate with devices. It communicates with microcontroller using serial port (USART) and other devices. Usually, it connects small devices: mobile phones and TVs using a short-range wireless connection to exchange documents. Its frequency band is 2.45GHz. The connection can be point-to-point or multi-point where the maximum range is 9 meters or 30 feet. The data transfer rate is 1Mbps.

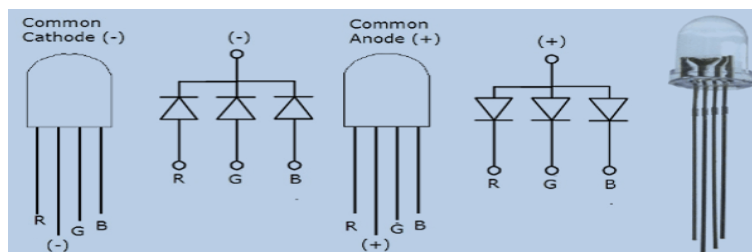
HC05 Bluetooth module provides switching mode between master and slave mode which means it able to use neither receiving nor transmitting data.[Cotta A.& at el,2016]



**Figure 5** The photograph and pin diagram of the HC-05 Bluetooth module

### RGB Light Emitting Diode

A light-emitting diode (LED) is a semiconductor light source that emits light when current flows through it. Electrons in the semiconductor recombine with electron holes to release energy in the form of photons. This is called electroluminescence. The color of the light (corresponding to the energy of the photons) is determined by the energy required for electrons to cross the band gap of the semiconductor. White light is obtained by using multiple semiconductors or a layer of light-emitting on the semiconductor device.[Mohdparvez A.,2017]



**Figure 6** The photograph and pin diagram of the RGB LED

### Construction of the circuit

The data pin of LM35 connects the A0 of Arduino Uno to take the output of the sensor. The RS, E, D4, D5, D6 and D7 of LCD pins connect the D13, A1 to A5 of Arduino Uno pins to show the current temperature in degree Celsius and conditions. The D9, D10 and D11 pins of Arduino connect each three-color pin of RGB LED to lit respective color according to the different temperature ranges. The buzzer pin connects the D5 of Arduino pin to alert hot temperature range. The fan with motor also connects the D8 of Uno to cool the surrounding temperature. The RX pin of the Bluetooth module is connected to the TX pin of the Arduino, and the TX of the Bluetooth module to the RX of the Arduino to communicate the user android phone. The power pin of each device connects the 5V pin of Arduino. Similarly, the ground pin of each device connects the GND pin of Arduino. The complete circuit diagram, photograph of the assembly of the temperature indicator and blue tooth android application are shown in Figure 7, 8 and 9.

### Operation of the system

When the power supply applies to the system, a temperature sensor LM35 senses the surrounding temperature. It transfers the precision signal to the Arduino Uno microcontroller.

Arduino reads output voltage of temperature sensor by using Analog pin A0 and performs the calculation to convert this Analog value to a digital value of current temperature. After calculations, Arduino sends these calculated data's or temperature to 16x2 LCD and user's android phone simultaneously. RGB LED will produce the respective color according to the five different temperature ranges and the real surrounding temperature displays on the LCD screen and android phone. If the received temperature range (freeze) is below and equal 5°C, RGB LED produces white color. If the calculated temperature range (low or cold) is between above 5°C and 20°C, RGB LED becomes the blue color. If the normal range is between 20 and 30°C, RGB comes the green color. And then if the hot range is between 30°C and 40°C, the magenta color will open from RGB LED. If the very hot temperature range is above 40°C, the RGB will produce red color. The buzzer and fan will play and alert signal to the user's phone from Bluetooth when the temperature goes above 30°C. The several surrounding temperatures displayed on the user's phone screen all the time. The flow chart diagram of the temperature indicator circuit is as shown in Figure 10.

### **Results and Discussion**

The research is a temperature sensor made with an Arduino Uno and LM35 sensor and a few other components. The working of the system starts with the LM35 sensor that senses the change in temperature of the surrounding and uses that temperature difference to produce a voltage signal which processes by the Arduino to give a digital output displaying the temperature of the surrounding. The system is to detect the temperature of the surroundings and display on the LCD screen and alert on the user's phone screen, fan and buzzer. The buzzer and fan will open if the sensor senses very hot (above 40°C) temperature range. The photographs of the different temperature range are shown in Figure 11 to Figure 14.

The system is successful in building a monitoring device which works as a thermometer for measuring temperature inside a building and outdoors. The performance of the system is accurate and reliable. Arduino based this device is the new possibilities for developing smart devices freely with low cost.

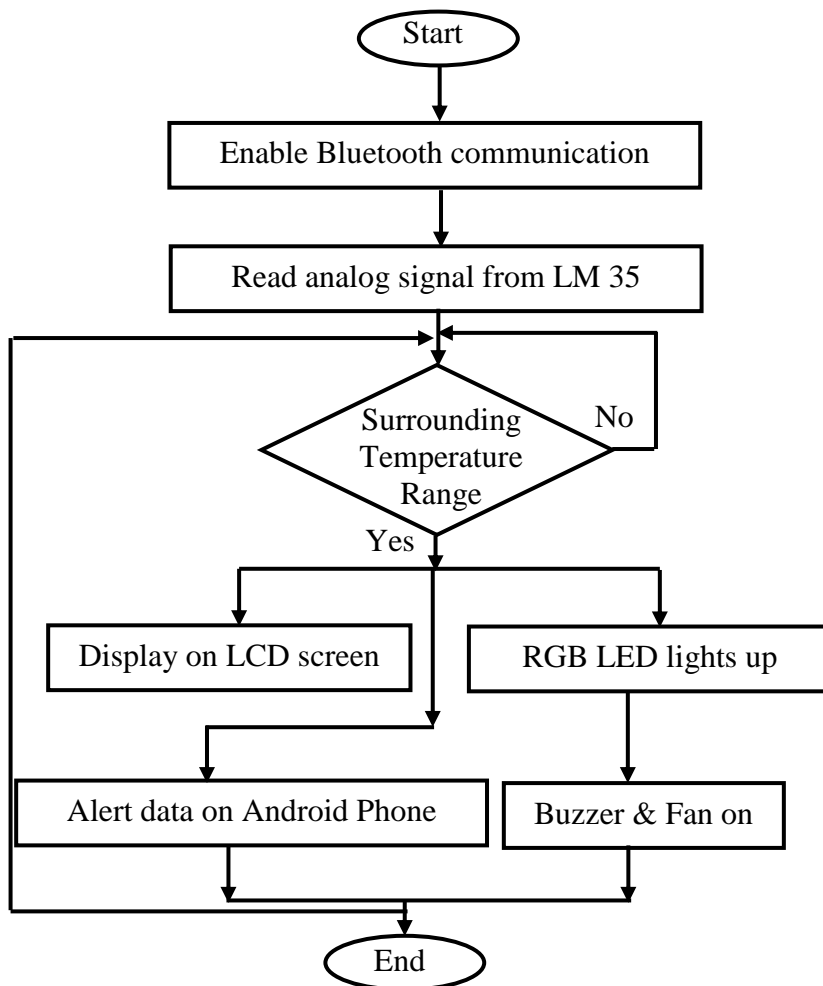


Figure 7 The Flow chart diagram of the temperature indicator circuit

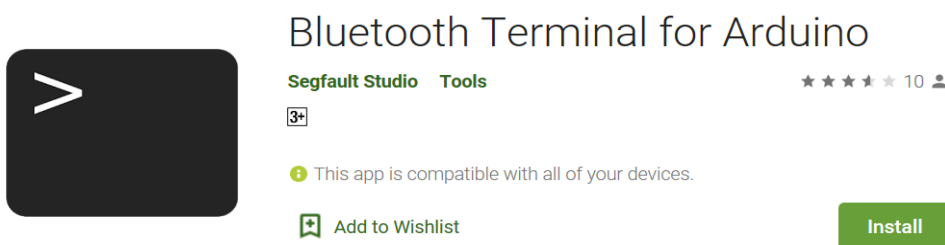


Figure 8 The photograph of Bluetooth android application for temperature data

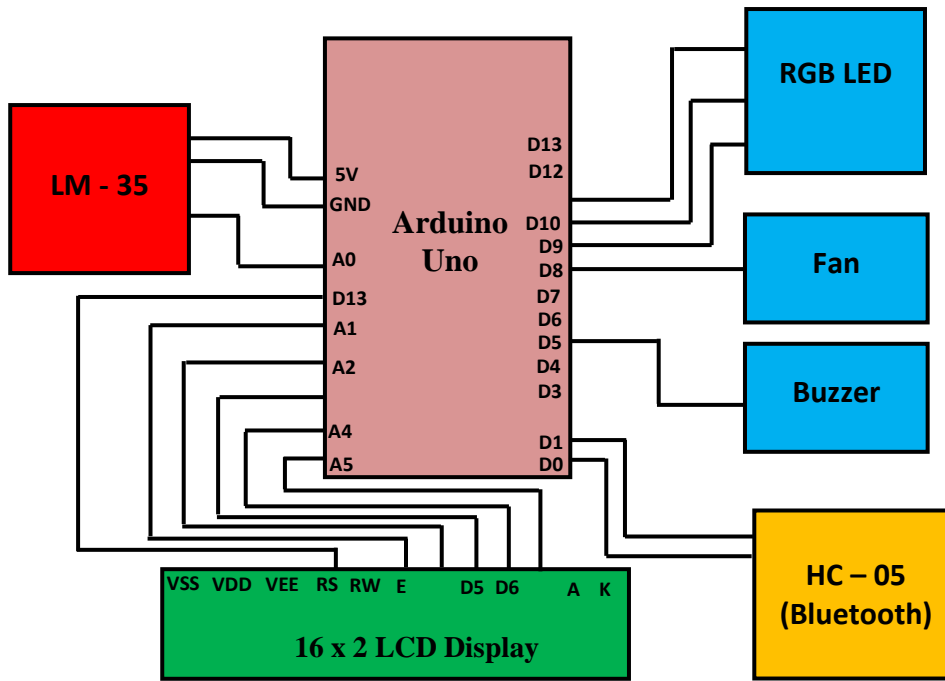


Figure 9 The complete diagram of the temperature indicator circuit



Figure 10 The photograph of the assembly of the temperature indicator circuit



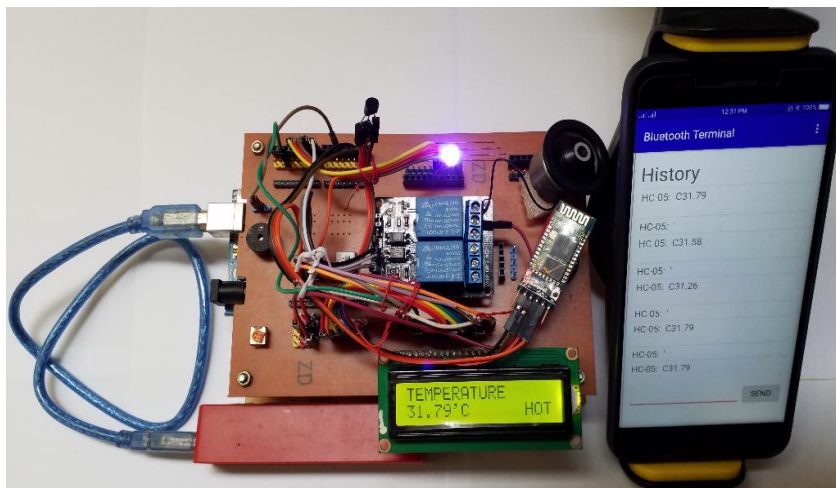
Figure 11 The photograph of the Freeze (less than 5°C) temperature range of the system



**Figure 12** The photograph of Low (between above 5°C and 20°C) temperature rang of the system

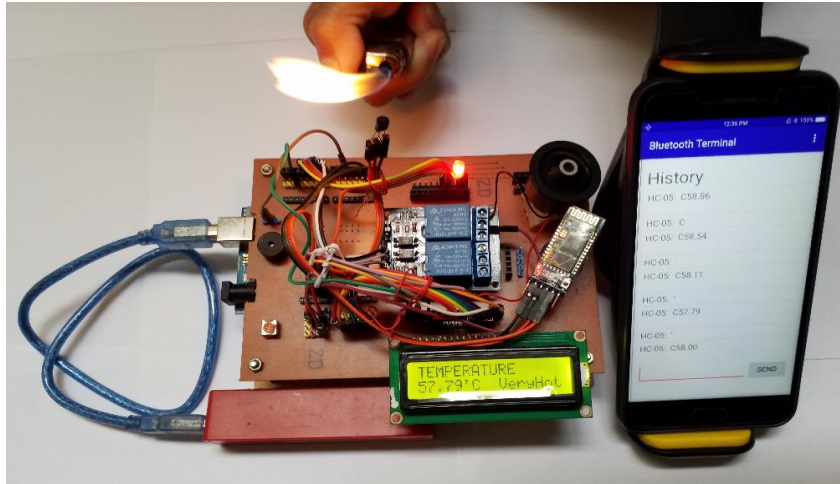


**Figure 13** The photograph of normal (between 20°C and 30°C) temperature range of the system



**Figure 14** The photograph of the hot (between 30°C and 40°C) temperature range of the system





**Figure 15:** The photograph of the very hot (above 40°C) temperature range of the system

### Conclusion

The Arduino based temperature indicator circuit can be divided into four sections: the first section (power supply) supplies the system, second section (sensor part) senses the heat by using temperature sensor LM35, third section (control part) converts the temperature value into a suitable number in Celsius scale which is done by Arduino, and last section (output part) of system displays and alerts temperature on LCD, android phone, RGB LED, fan and buzzer.

The temperature sensor on the other hand can be used to measure the safety limit temperature to prevent excessive temperature as a thermometer. The system is a very essential protection circuit and alert the hazardous heat. Therefore, it can be used in houses, offices, industries, a region of active volcano and etc.

### Future Work

The Bluetooth is the communication technology of the wireless device. Its modules can transmit and receives the data wirelessly by using other devices. The HC05 Bluetooth module cannot sense a range of up to 9 meters (30ft). If the user is away from the 30ft, the connection lost. Therefore, this system will connect the GSM or Wi-Fi module to accept the temperature data later. And then it will add the Internet of thing (IOT) technology to communicate the data quickly and wide range.

### Acknowledgements

I would like to thank Professor Dr Khin Khin Win, Head of Department of Physics, Yangon University for her constant support during this work.

I would also like to thank Professor Dr Khin Mar Ohn, Head of Department of Physics, Bago University for her useful advice and encouragement to complete work.

I would like to express sincere thanks to Dr Khin Htoo, Professor, Department of Physics, Bago University, for her helpful encouragement in the preparation of this work.

## References

- Arduino based digital temperature sensor, (2016). <https://create.arduino.cc/projecthub/abishek-bhalaaji>
- Badamasi Y. A., (2014). "The working principle of an Arduino, Electronics, Computer and Computation".
- Cotta A., Trupti Devidas N., and Devidas N. E., (2016) "Wireless Communication Using Hc-05 Bluetooth Module Interfaced with Arduino" International Journal of Science, Engineering and Technology Research (IJSETR), India, vol. 5, Issue 4, pp.869-872.
- Michael M., (2014) "Beginning Arduino", Second Edition, California.
- Mohdparvez A., Swamy S., Sukka B., Vijaya B. and S.V. Altaf, (2017) "Multiple Colour Generation by using RGB LED" International Journal for Scientific Research & Development, India, vol.5,pp.5-7.
- Pimpalgaonkar A., Mansi Jha, Shukla N., Asthana K., (2013) "A Precision Temperature Controller using Embedded System", International Journal of Scientific and Research Publications, vol.3, no.12, pp.1-3.